

**AWM**

**AWM  
AMARO**

**I.AM**

Thinking  
Works

**Specification Guide**

[awm.net.au](http://awm.net.au)

# I.AM

Round/Square

6 – 10



Meeting Tables

11 – 13



Multi-Leg

14 – 15

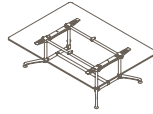

Folding

16

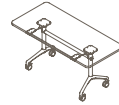

Features

17 – 18

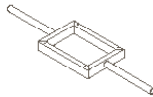

# Multi-Leg Finishes

## 1. Frame Finishes

Standard I.AM frame finishes include black legs with a polished foot. I.AM is also available with chrome legs with a polished foot or in our current season powdercoat colours listed, with custom colour optional.

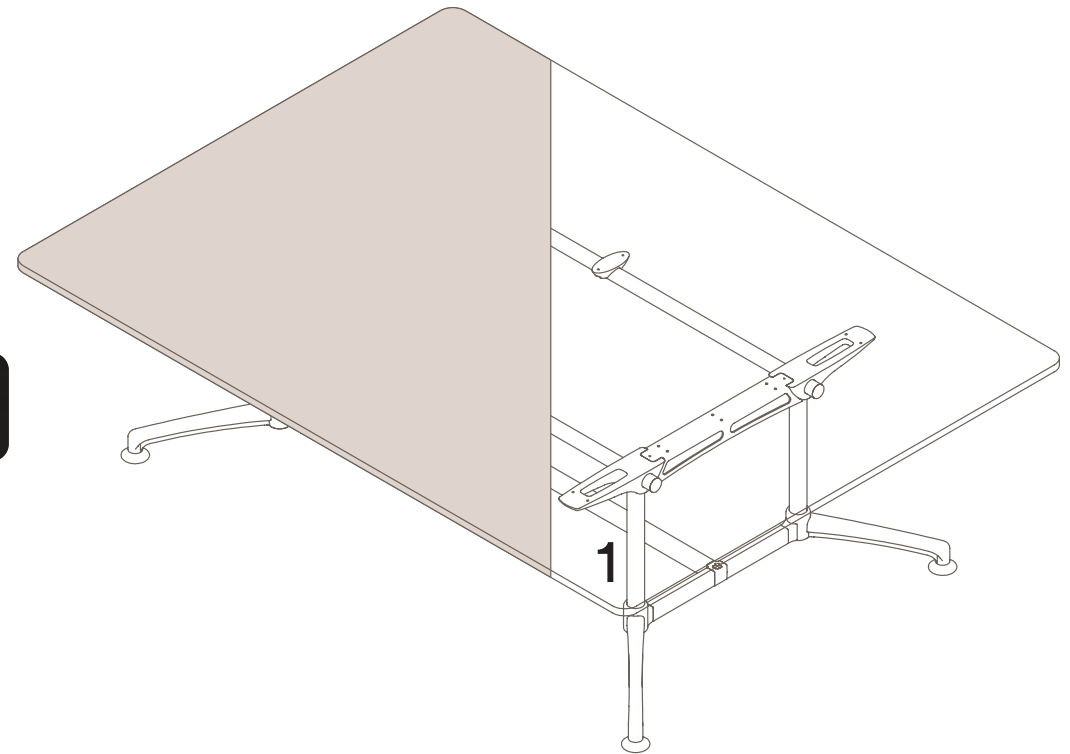
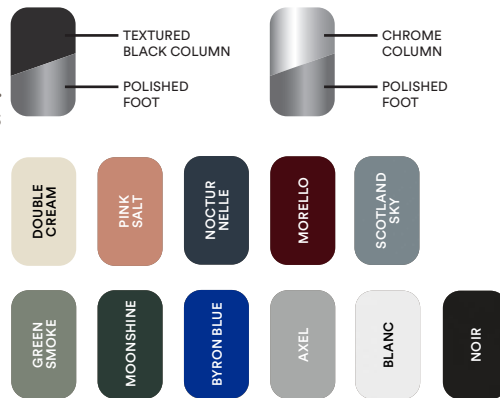

Colours are representative only, please check with your Thinking Works consultant to view samples of any specific colour.

# Tables Round / Square

## Materials Information

### Leg Finish

Steel Leg Column

- a. Textured Black (standard)
- b. Chrome
- c. Blanc
- d. Noir
- e. Double Cream
- f. Pink Salt
- g. Nocturnelle
- h. Morello
- i. Scotland Sky
- j. Green Smoke
- k. Moonshine
- l. Byron Blue
- m. Axel

## I-1020

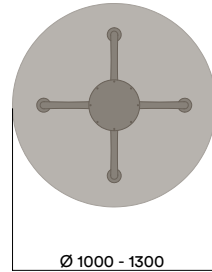

## 720 (standard Height)

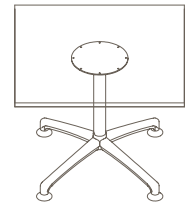
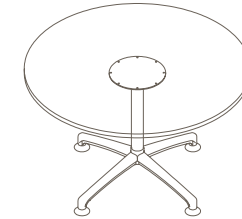
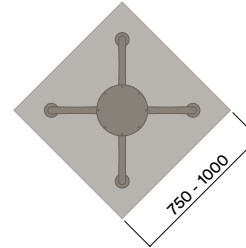

## I-1021 Castors

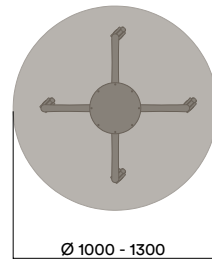

## 720 (standard Height)

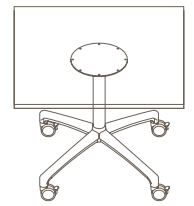
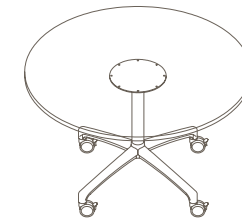
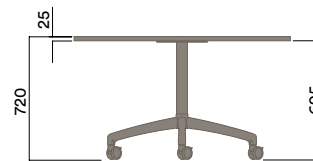
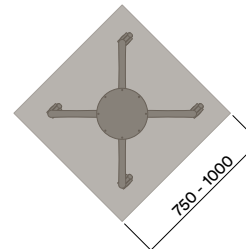

### Foot Finish

Aluminium Foot

- a. Polished (standard)
- b. Powdercoat (to match column)

### Frame Finish

Steel Top Horn

- a. Black Powdercoat

\* Maximum Custom Height 1000mm on Glides  
900mm on Castors

Maximum inc. worktop 40kg  
Maximum Point Load 50kg  
Seats 4

# Tables

## Round / Square

### Materials Information

#### Leg Finish

Steel Leg Column

- a. Textured Black (standard)
- b. Chrome
- c. Blanc
- d. Noir
- e. Double Cream
- f. Pink Salt
- g. Nocturnelle
- h. Morello
- i. Scotland Sky
- j. Green Smoke
- k. Moonshine
- l. Byron Blue
- m. Axel

### I-1025 Folding

### 720 (standard Height)

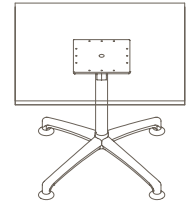
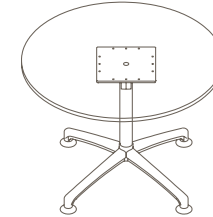
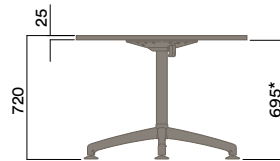
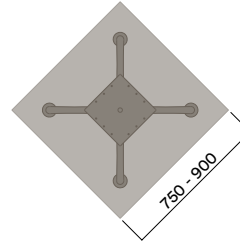
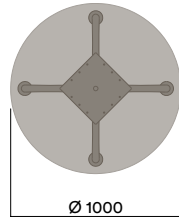

### I-1026 Folding on Castors

### 720 (standard Height)

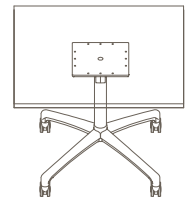
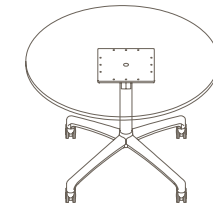
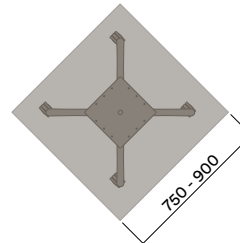
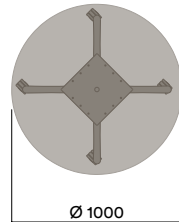

#### Foot Finish

Aluminium Foot

- a. Polished (standard)
- b. Powdercoat (to match column)

\* Maximum Custom Height 1000mm on Glides  
900mm on Castors  
Maximum inc. worktop 40kg  
Maximum Point Load 50kg  
Seats 4

# Tables

## Round / Square

### Materials Information

#### Leg Finish

Steel Leg Column

- a. Textured Black (standard)
- b. Chrome
- c. Blanc
- d. Noir
- e. Double Cream
- f. Pink Salt
- g. Nocturnelle
- h. Morello
- i. Scotland Sky
- j. Green Smoke
- k. Moonshine
- l. Byron Blue
- m. Axel

#### Foot Finish

Aluminium Foot

- a. Polished (standard)
- b. Powdercoat (to match column)

#### Frame Finish

Steel Top Horn

- a. Black Powdercoat

\* Maximum Custom Height 695mm  
 Maximum inc. worktop 20kg  
 Maximum Point Load 30kg  
 Seats 4

### I-1030

### 720 (standard Height)

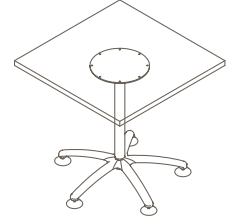
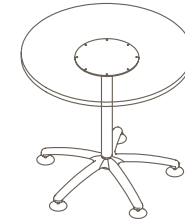
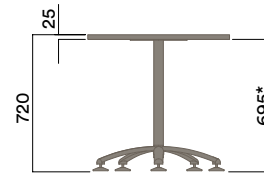
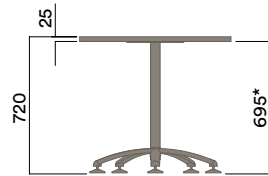
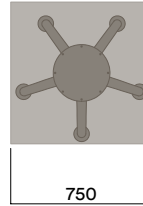
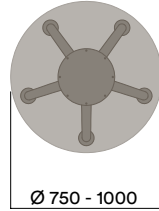

### I-1031 Castors

### 720 (standard Height)

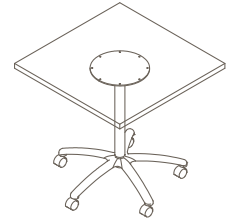
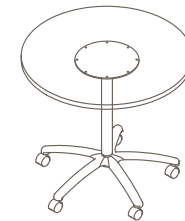
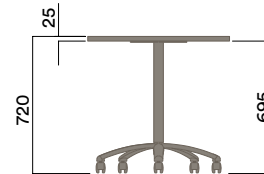
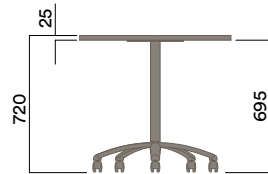
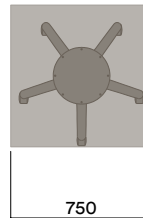
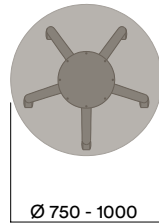

# Tables

## Round / Square

### Materials Information

#### Leg Finish

Steel Leg Column

- a. Textured Black (standard)
- b. Chrome
- c. Blanc
- d. Noir
- e. Double Cream
- f. Pink Salt
- g. Nocturnelle
- h. Morello
- i. Scotland Sky
- j. Green Smoke
- k. Moonshine
- l. Byron Blue
- m. Axel

#### Foot Finish

Aluminium Foot

- a. Polished (standard)
- b. Powdercoat (to match column)

#### Frame Finish

Steel Top Horn

- a. Black Powdercoat

Maximum inc. worktop 20kg  
 Maximum Point Load 30kg  
 Seats 4

### I-1032 Castors

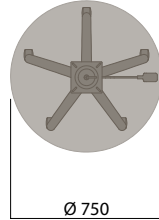

### Gas Lift Height Adjustable

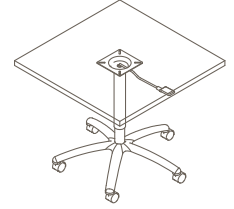
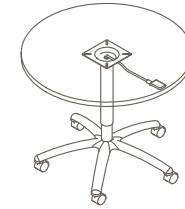
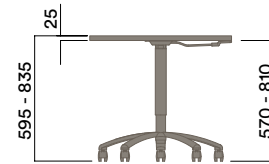
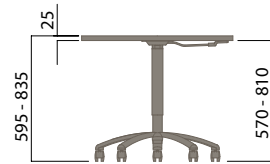
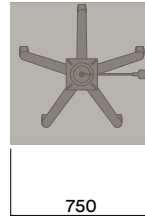

### I-1033

### Gas Lift Height Adjustable

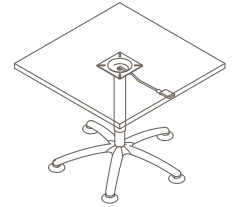
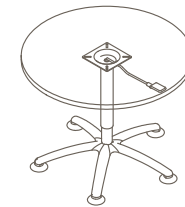
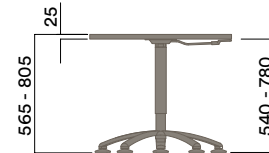
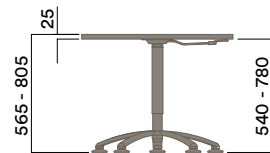
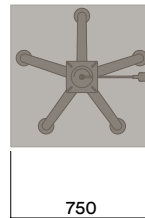
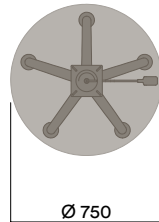

# Tables

## Round / Square

### Materials Information

#### Leg Finish

Steel Leg Column

- a. Textured Black (standard)
- b. Chrome
- c. Blanc
- d. Noir
- e. Double Cream
- f. Pink Salt
- g. Nocturnelle
- h. Morello
- i. Scotland Sky
- j. Green Smoke
- k. Moonshine
- l. Byron Blue
- m. Axel

### I-1035 Folding

### 720 (standard Height)

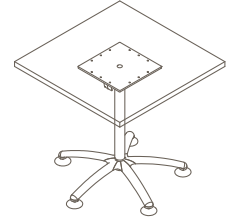
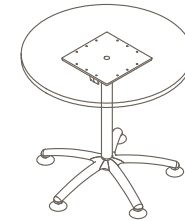
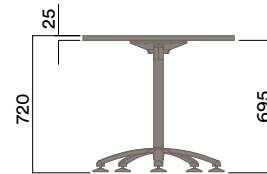
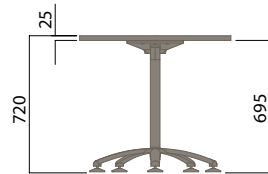
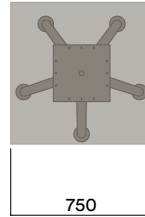
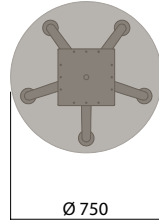

### I-1036 Folding on Castors

### 720 (standard Height)

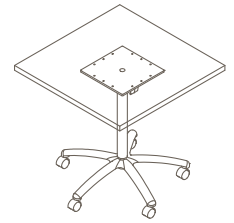
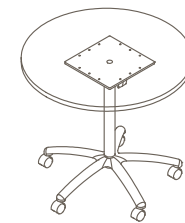
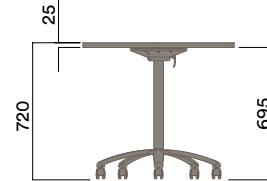
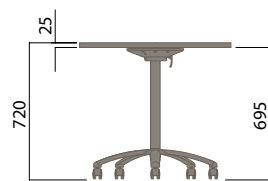
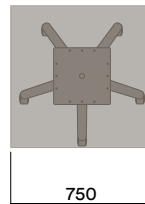
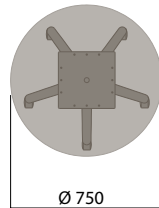

#### Foot Finish

Aluminium Foot

- a. Polished (standard)
- b. Powdercoat (to match column)

Maximum inc. worktop 20kg  
 Maximum Point Load 30kg  
 Seats 4



# Tables

## Rectangle

### Materials Information

#### Leg Finish

Steel Leg Column

- a. Textured Black (standard)
- b. Chrome
- c. Blanc
- d. Noir
- e. Double Cream
- f. Pink Salt
- g. Nocturnelle
- h. Morello
- i. Scotland Sky
- j. Green Smoke
- k. Moonshine
- l. Byron Blue
- m. Axel

#### Foot Finish

Aluminium Foot

- a. Polished (standard)
- b. Powdercoat (to match column)

#### Frame Finish

Polished Aluminium Top Horn  
Steel Black Powdercoat Rails

\* Maximum Custom Height 1000mm on Glides  
900mm on Castors

Maximum inc. worktop 100kg  
Maximum Point Load 50kg  
Seats 4-6

I-1000, I-1001, I-1002

720 (standard Height)

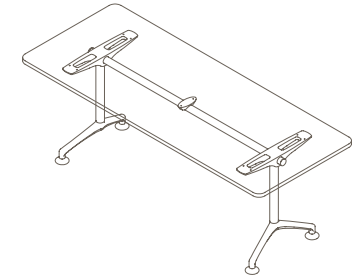
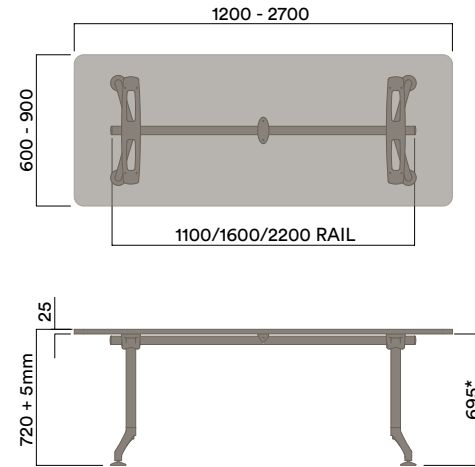

I-1010, I-1011, I-1012

720 (standard Height)

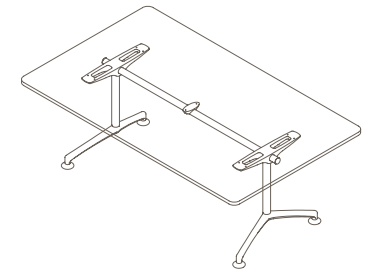
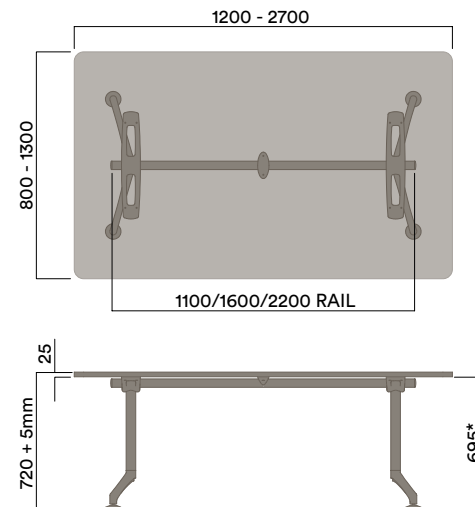

# Tables

## Rectangle

### Materials Information

#### Leg Finish

Steel Leg Column

- a. Textured Black (standard)
- b. Chrome
- c. Blanc
- d. Noir
- e. Double Cream
- f. Pink Salt
- g. Nocturnelle
- h. Morello
- i. Scotland Sky
- j. Green Smoke
- k. Moonshine
- l. Byron Blue
- m. Axel

#### Foot Finish

Aluminium Foot

- a. Polished (standard)
- b. Powdercoat (to match column)

#### Frame Finish

Polished Aluminium Top Horn  
Steel Black Powdercoat Rails

\* Maximum Custom Height 1000mm  
Maximum inc. worktop 130kg  
Maximum Point Load 50kg  
Seats 6-18

### I-1040

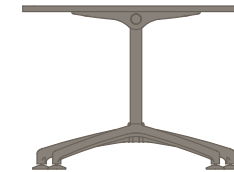
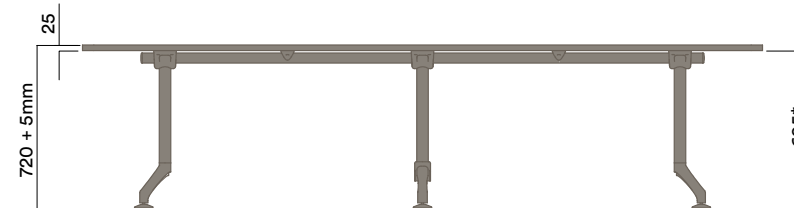
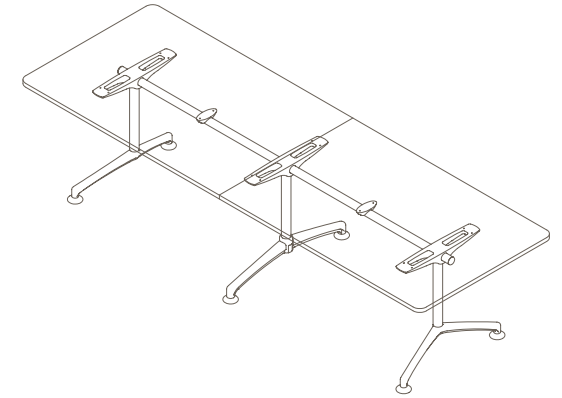
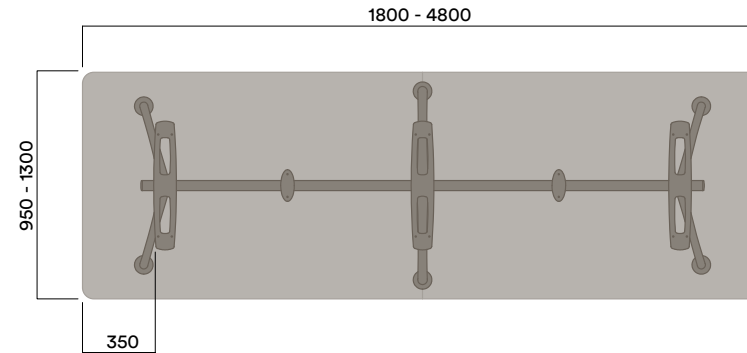

### I-1041

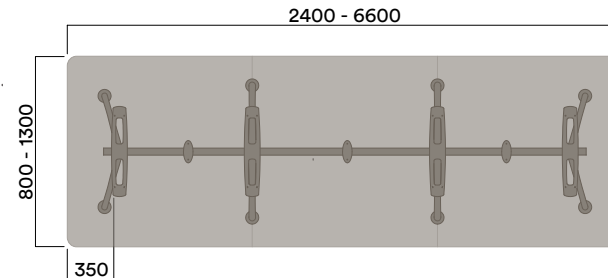

# Tables Boatshape

## Materials Information

### Leg Finish

Steel Leg Column

- a. Textured Black (standard)
- b. Chrome
- c. Blanc
- d. Noir
- e. Double Cream
- f. Pink Salt
- g. Nocturnelle
- h. Morello
- i. Scotland Sky
- j. Green Smoke
- k. Moonshine
- l. Byron Blue
- m. Axel

### Foot Finish

Aluminium Foot

- a. Polished (standard)
- b. Powdercoat (to match column)

### Frame Finish

Polished Aluminium Top Horn  
Steel Black Powdercoat Rails

I-1044

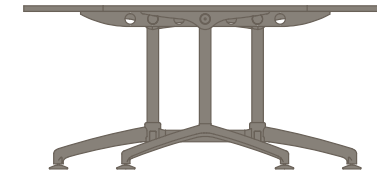
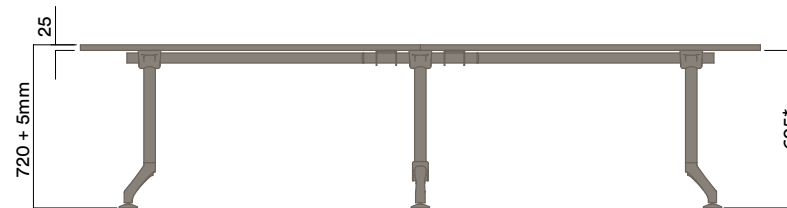
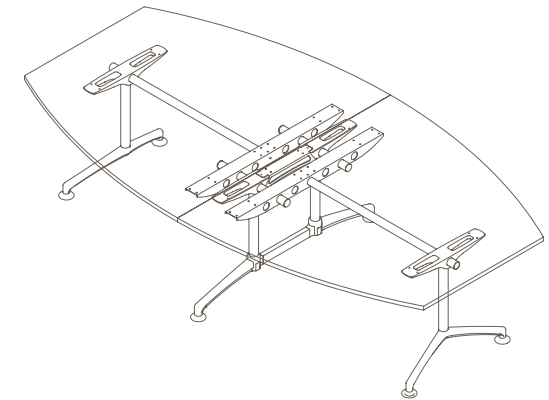
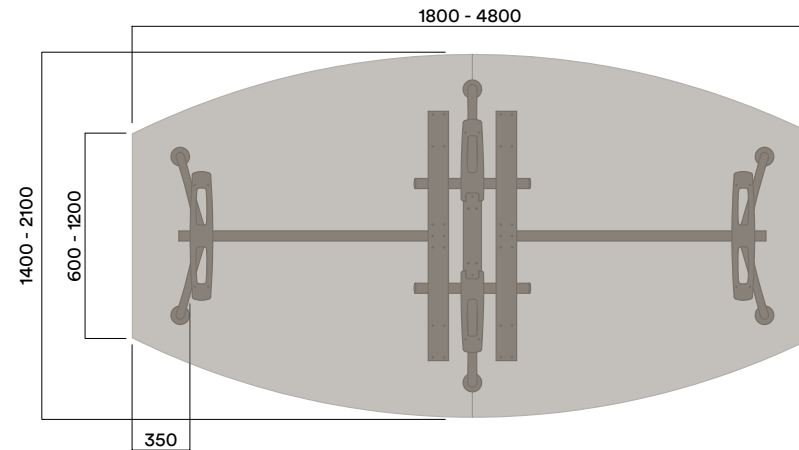

I-1046

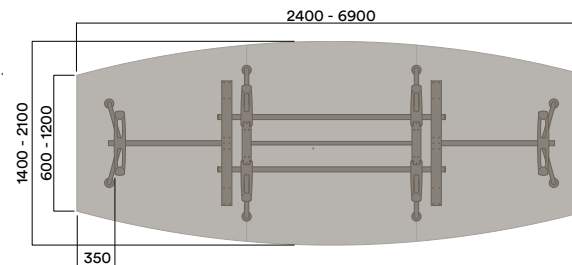

\* Maximum Custom Height 1000mm  
Maximum inc. worktop 160kg  
Maximum Point Load 50kg  
Seats 6-18

# Multi-Leg Round/Square

## Materials Information

I-1070

### Leg Finish

Steel Leg Column and Lower Frame

- a. Textured Black (standard)
- b. Chrome
- c. Blanc
- d. Noir
- e. Double Cream
- f. Pink Salt
- g. Nocturnelle
- h. Morello
- i. Scotland Sky
- j. Green Smoke
- k. Moonshine
- l. Byron Blue
- m. Axel

### Foot Finish

Aluminium Foot

- a. Polished - Standard
- b. Powdercoat - to match frame

### Frame Finish

Polished Aluminium Top Horn

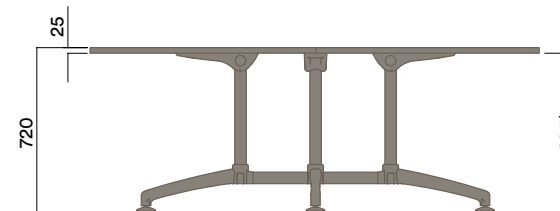
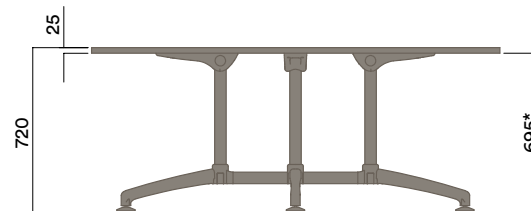
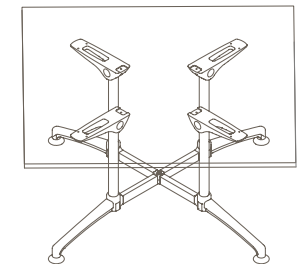
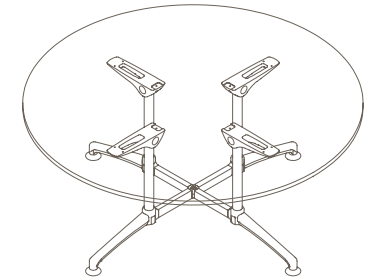
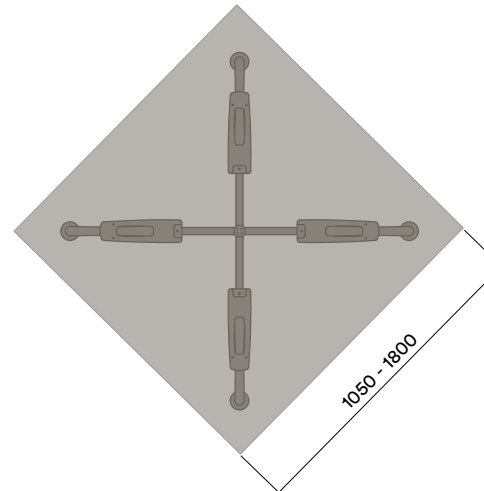
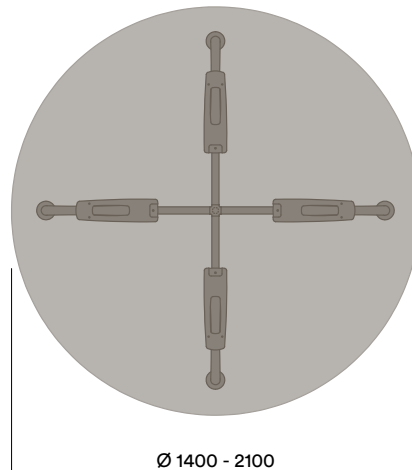

\* Maximum Custom Height 1000mm  
Maximum inc. worktop 80kg  
Maximum Point Load 50kg  
Seats 4-6

# Multi-Leg Rectangle

## Materials Information

### Leg Finish

Steel Leg Column

- a. Textured Black (standard)
- b. Chrome
- c. Blanc
- d. Noir
- e. Double Cream
- f. Pink Salt
- g. Nocturnelle
- h. Morello
- i. Scotland Sky
- j. Green Smoke
- k. Moonshine
- l. Byron Blue
- m. Axel

### Foot Finish

Aluminium Foot

- a. Polished (standard)
- b. Powdercoat (to match column)

### Frame Finish

Polished Aluminium Top Horn  
Steel Black Powdercoat Rails

\* Maximum Custom Height 1000mm  
Maximum inc. worktop 160kg  
Maximum Point Load 50kg  
Seats 4-24

## I-1050 4 Leg

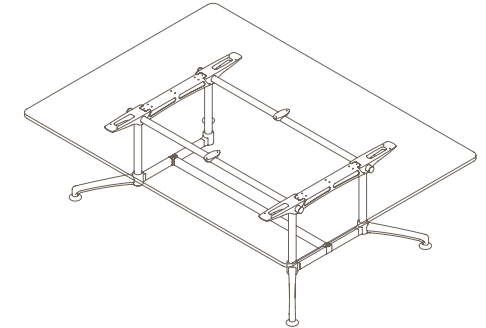
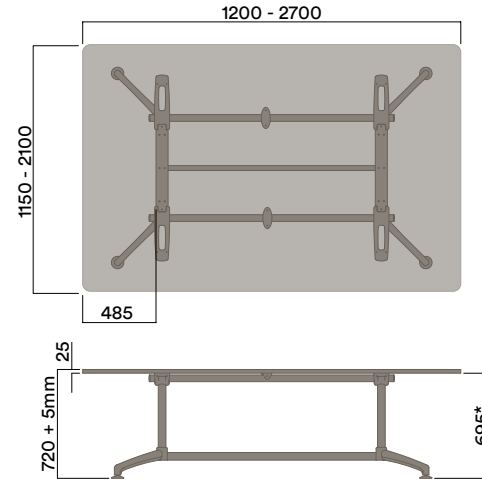

## I-1051 6 Leg

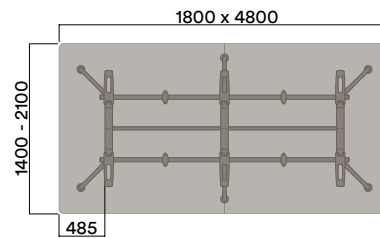

## I-1052 8 Leg

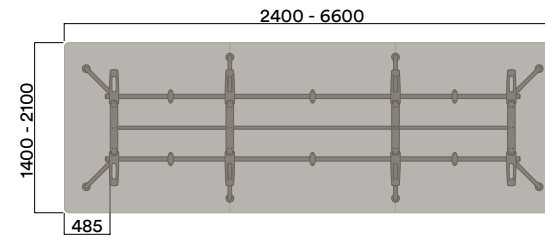

## I-1053 10 Leg

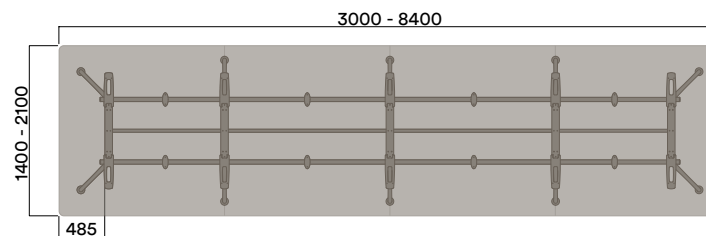

# Tables Folding

## Materials Information

### Leg Finish

Steel Leg Column

- a. Textured Black (standard)
- b. Chrome
- c. Blanc
- d. Noir
- e. Double Cream
- f. Pink Salt
- g. Nocturnelle
- h. Morello
- i. Scotland Sky
- j. Green Smoke
- k. Moonshine
- l. Byron Blue
- m. Axel

I-1080 , I-1082, I-1084, I-1086 720 (standard Height)

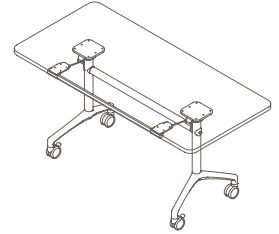
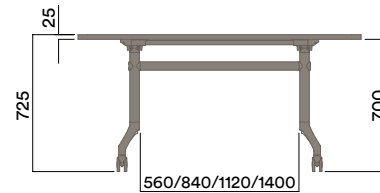
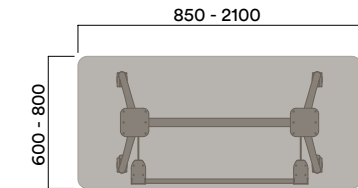

I-1081, I-1083, I-1085, I-1087 720 (standard Height)

### Foot Finish

Aluminium Foot

- a. Polished (standard)
- b. Powdercoat (to match column)

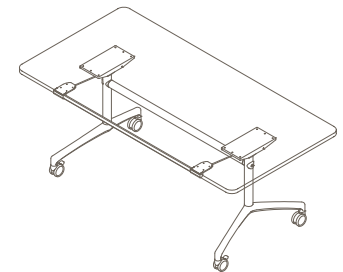
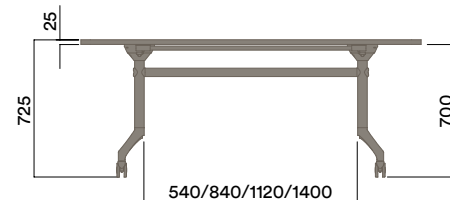
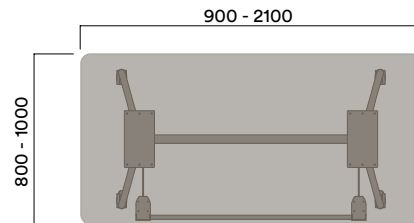

\* Maximum Custom Height 1000mm on Glides  
900mm on Castors  
Maximum inc. worktop 24kg  
Maximum Point Load 30kg  
Seats 4-6

# Tables Features

## Materials Information

### Frame Finish

Steel Slingshot

a. Powdercoat (to match frame)

Steel Power/Data Beam

a. Black Powdercoat

### Powerbox Slingshot

Suitable for I-1040 and I-1041 table frames

Replaces I.AM leg column to provide placement of powerboxes without frame interference

Made to order to cater for specified powerbox requirements and size

Provides 75mm clearance around powerbox to ensure fitment without frame interference

### Power/Data Beam

Suitable for I-1000, I-1001 and I-1002 frames

Suitable for I-1010, I-1011 and I-1012 frames

Replaces central rail to provide placement of powerboxes without frame interference

Made to order to cater for specified powerbox requirements and size

Provides 50mm clearance around powerbox to ensure fitment without frame interference

## Powerbox Management

## Slingshot

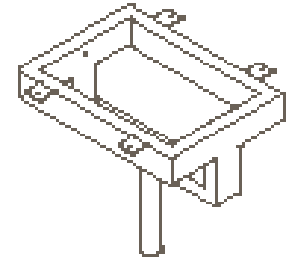
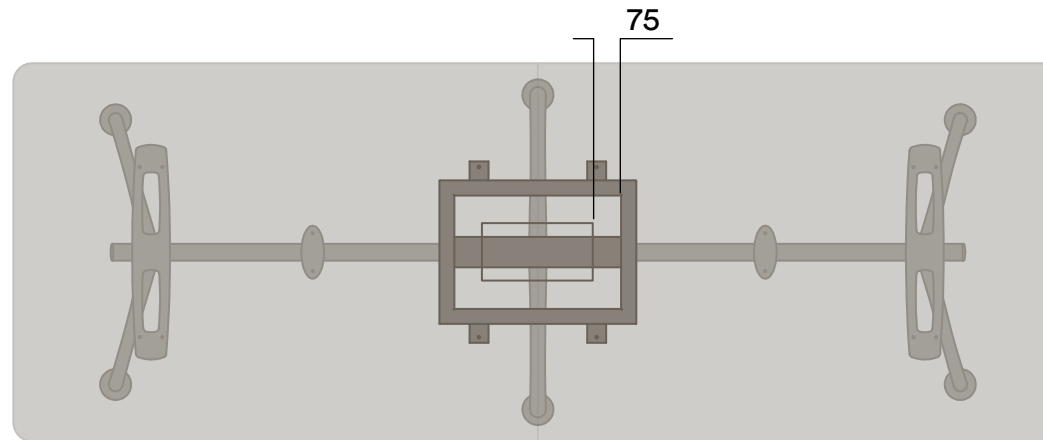

## Powerbox Management

## Power/Data Beam

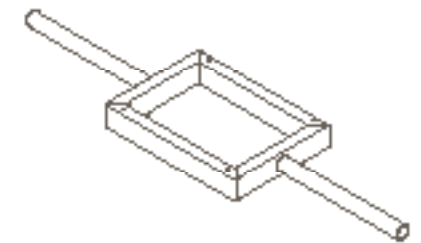
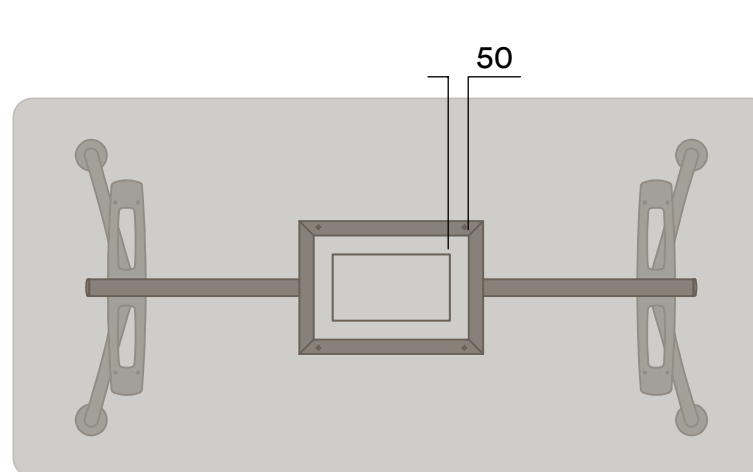

# Tables Features

## Materials Information

### Frame Finish

Steel Multi-Leg Spacer

a. Black Powdercoat

Steel Outrigger

a. Black Powdercoat

## Powerbox Management

## Multi-Leg Spacers

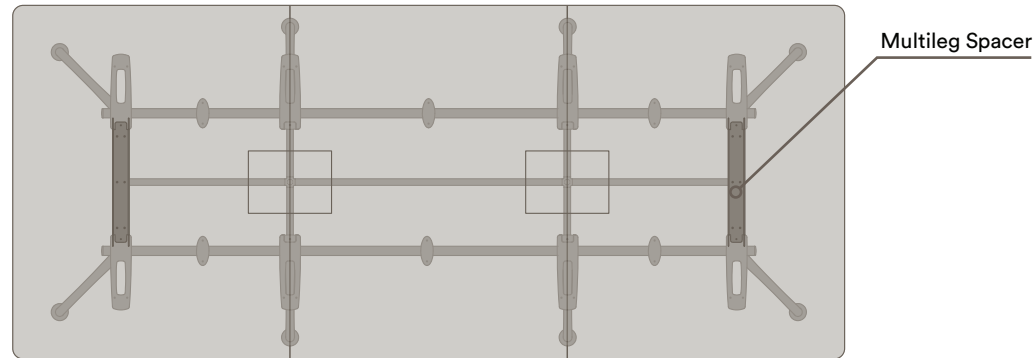

## Worktop Management

## Outriggers

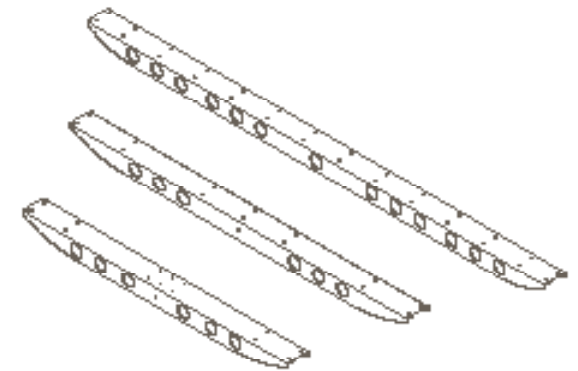
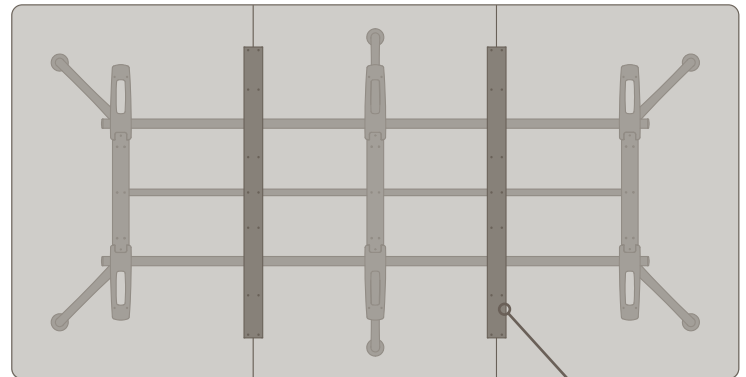

### Multi-leg Spacers

Provided with frame, spacers can be removed on-site to provide placement of powerboxes without frame interference

Applies to all Multi-Leg Rectangle Frames

### Outriggers

Additional Outriggers can be purchased to provide adequate worktop support on odd worktop splits

Outriggers available to suit SML, MED and LRG width Multi-Leg frames